

Emergency latrin (Fiber) Details

تفاصيل حمام طوارئ (فايبر)



PROJECT

15EJR
DALEA

TEAM

Designed By:
EJR WASH TEAM

DRAWING DETAILS:

Drawing Name:
Emergency Latrine.

Drawing Number:
EL (Fiber)
1-1

Drawing Date:
14/07/2021

Drawing Rev.:
A.001

0.20 m
 1 m
 2.2 m
 GI (zinc) with 0.3 mm thickness
 (صفيحة حديد مجلفن مموج
 لون ابيض
 سم 0.3 سماكة (زنك))

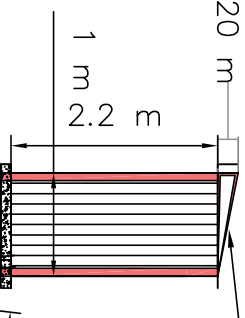

الواجهة الأمامية
 front view

5 m
 Sanitation pip, PVC, 4" to LP
 ماسورة صرف صحي 4" إلى البيرة "

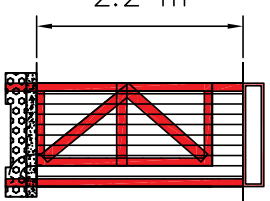

Zinc door with wood
 frame 0.8*1.7 m
 باب زنك مع إطار
 خشبي
 مقياس 1.7*0.8م

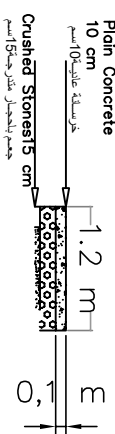

تفاصيل الأساس
 Base Details

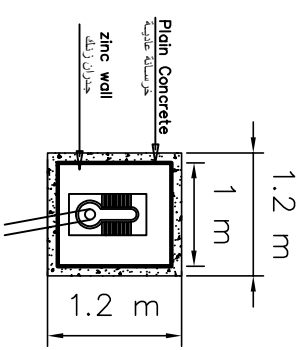

مقطع أفقي
 Top view

Emergency latrin (Zinc) Details تفاصيل حمام طارئ (زنك)

PROJECT

15EJR
 DALEA

TEAM

Designed By:
 EJR WASH TEAM

Checked and Approved By:
 Eng. WASH DPM

DRAWING DETAILS:

Drawing Name:
 Emergency Latrine.

Drawing Number:
 EL (Zinc)
 1-1

Drawing Date:
 14/07/2021

Drawing Rev.:
 A.001



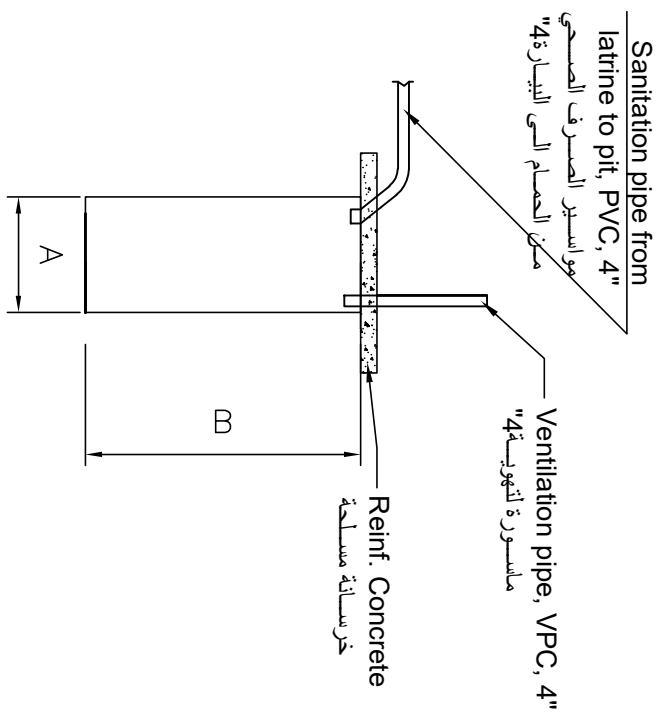

Pits without internal walls

بيارة بدون جدران

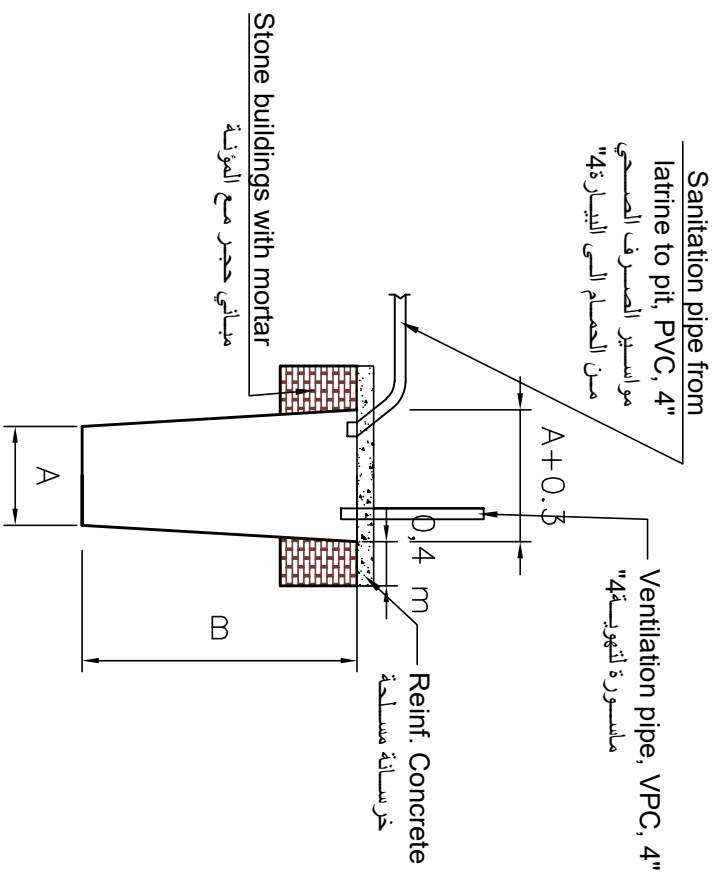

Pit with external walls

بيارة بجدران خارجية



ACTED
أكتد

PROJECT

15EJR
DALEA

TEAM

Designed By:
EJR WASH TEAM

Checked and Approved By:

Eng. **WASH DPM**

DRAWING DETAILS:

Drawing Name:

Emergency Latrine.

Drawing Number:

Latrine pits (type 1+2)
1-2

Drawing Date:

12/07/2021

Drawing Rev.:

A.001

Sanitation pipe from latrine to pit, PVC, 4"
مواسير الصرف الصحي من الحمام الى البقعة 4"

Ventilation pipe, VPC, 4"
مأسورة التهوية 4"

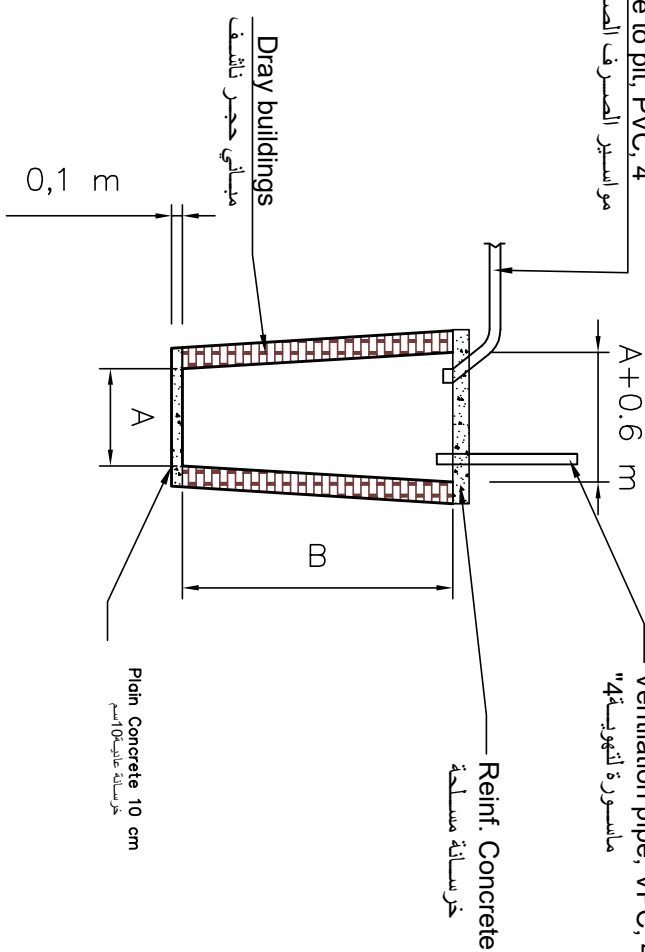

Latrine Pit Details if soil collapsed بيارة بجدران داخلية في حال التربة غير متمسكة

PROJECT

15EJR
DALEA

TEAM

Designed By:
EJR WASH TEAM

Checked and Approved By:

Eng. WASH DPM

DRAWING DETSILS:

Drawing Name:

Emergency Latrine.

Drawing Number:

Latrine pits (type 3)
2-2

Drawing Date:

12/07/2021

Drawing Rev.:

A.001



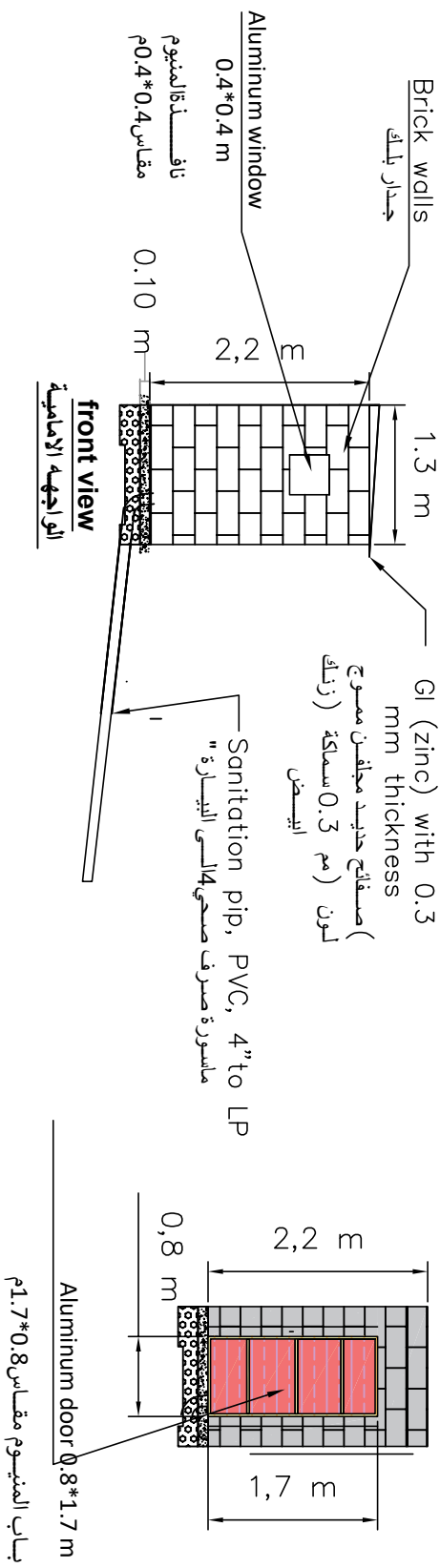

Emergency latrine(Brick walls+ Zinc roof) Details تفاصيل الحمام الطاري بجران بلك وسقف زنك



15EJR
DALEA

PROJECT

TEAM

Designed By:
EJR WASH TEAM

Checked and Approved By:
Eng. WASH DPM

DRAWING DETAILS:

Drawing Name:
Emergency Latrine.

Drawing Number:
EL (Brick)
1-1

Drawing Date:
14/07/2021

Drawing Rev.:
A.001